

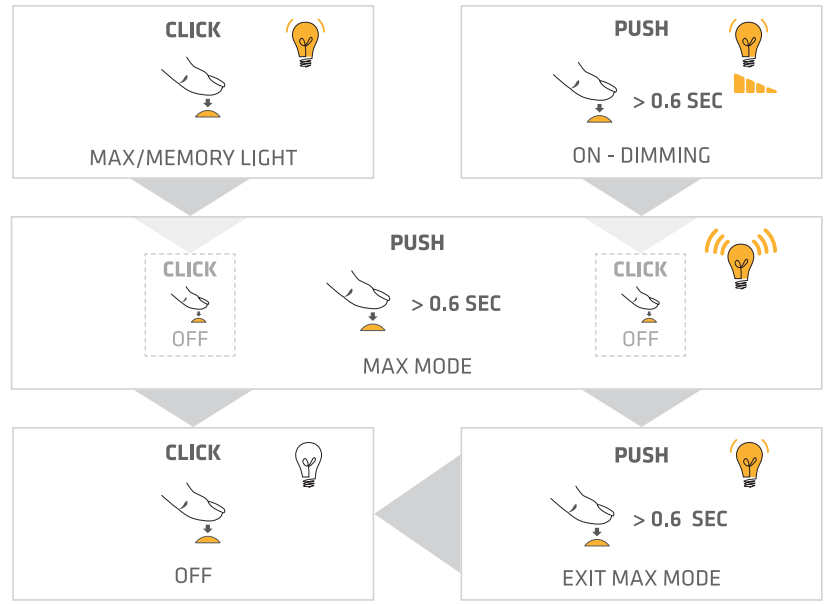

V3 pro rechargeable

Light Control Function



BACK LIGHT OFF/ON

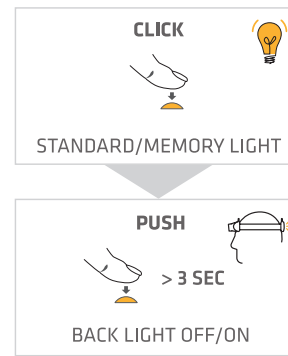

TRANSPORT LOCK

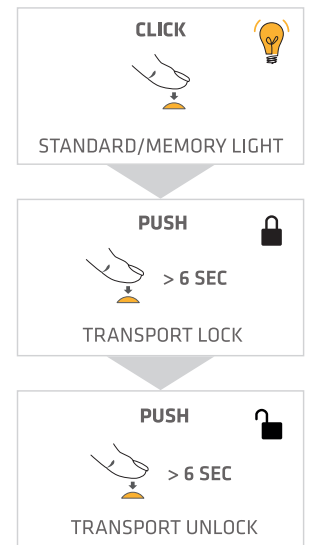

Hyperfocus, Head Angle and Cable

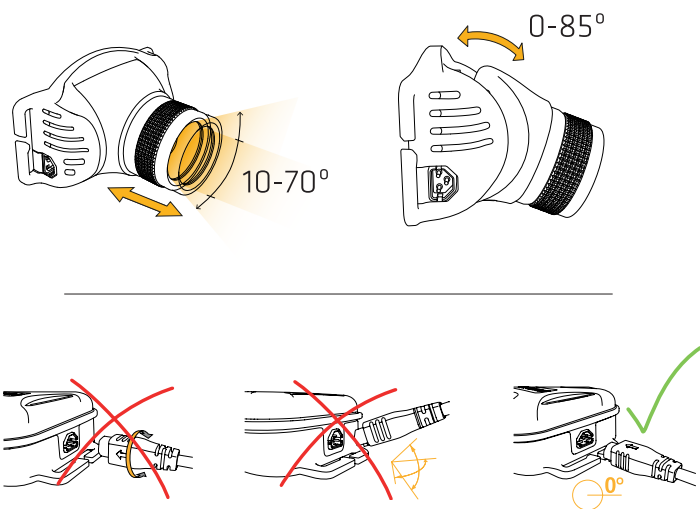

Charging (0°C - +45°C)

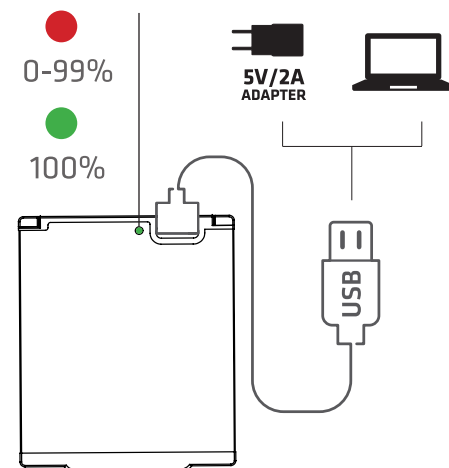

Additional Information

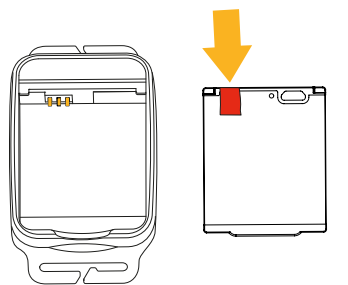

REMOVE SAFETY FOIL FROM THE BATTERY BEFORE USE



FOR MORE INFO

Warning



Specifications

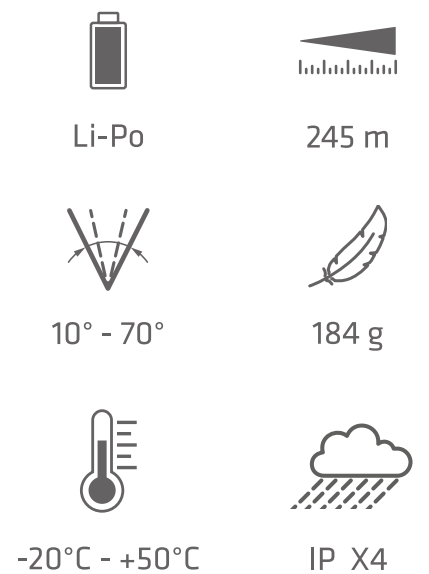

This manual may contain typographical errors. Data and information are subject to change without notice

Steiner A/S
Dyssen 3
DK-8200 Aarhus N
Phone: +45 87 52 52 12
Fax: +45 87 52 52 15
info@suprabeam.com
www.suprabeam.com

