

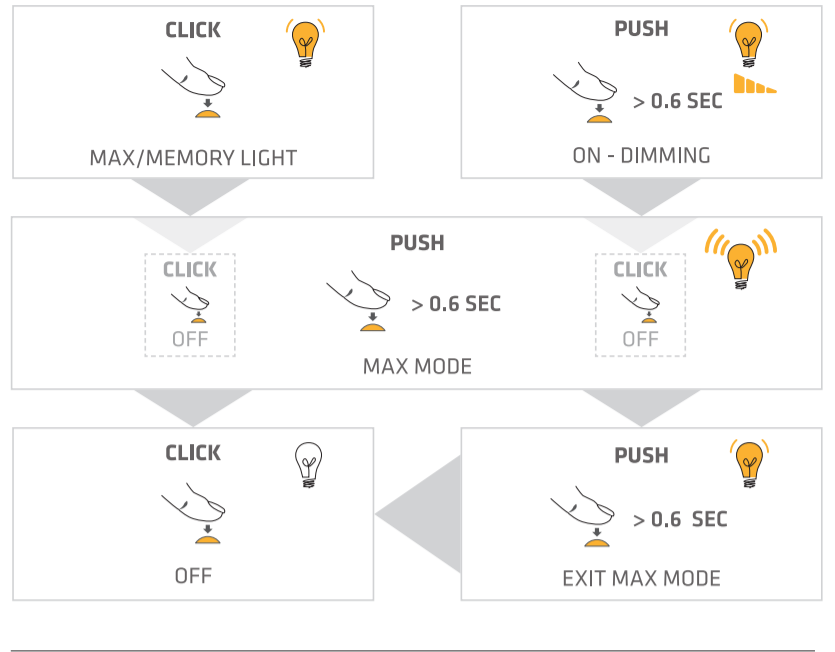

V4pro rechargeable

Light Control Function



BACK LIGHT OFF/ON

TRANSPORT LOCK

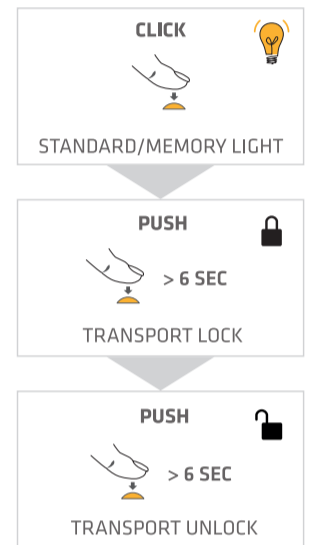
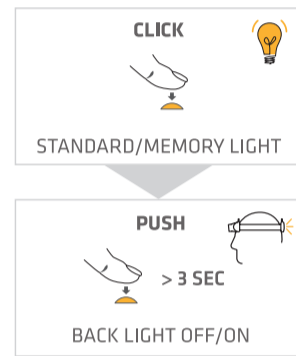

Head Angle and Cable

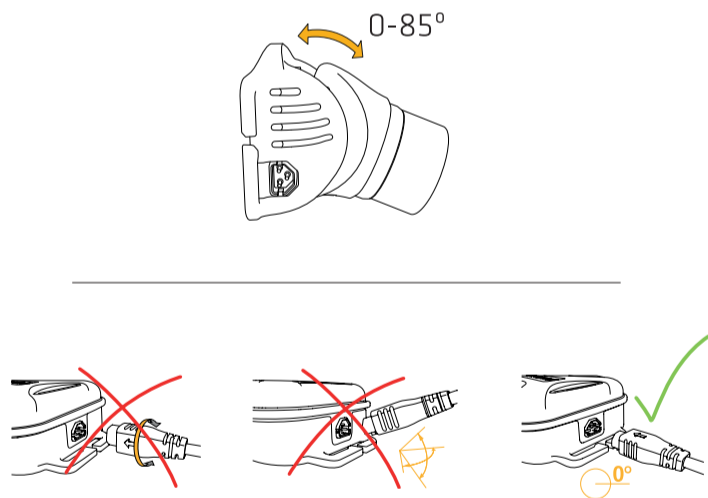

Charging (0°C - +45°C)

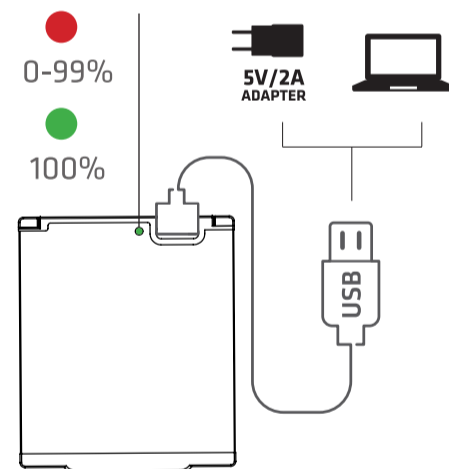

Additional Information

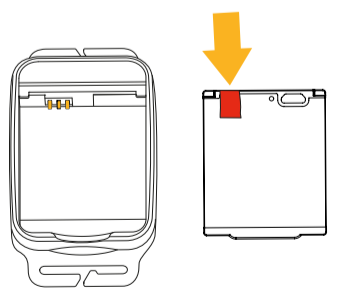

REMOVE SAFETY FOIL FROM THE BATTERY BEFORE USE



Warning



Specifications

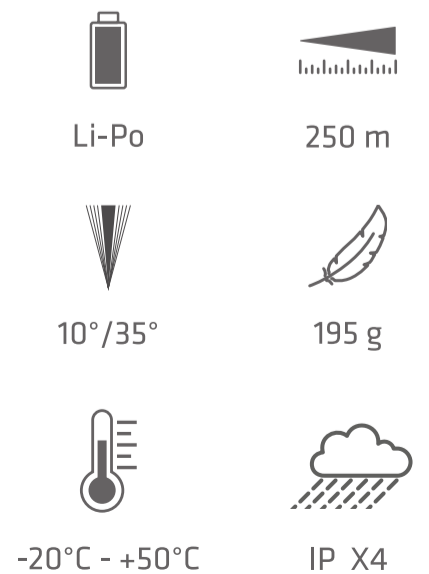

This manual may contain typographical errors. Data and information are subject to change without notice

Steiner A/S
Dyssen 3
DK-8200 Aarhus N
Phone: +45 87 52 52 12
Fax: +45 87 52 52 15
info@suprabeam.com
www.suprabeam.com

